

**ESCO**  
LIFESCIENCES



# Lexicon<sup>®</sup> II

*with Gold Controller*

**Ultra-Low Temperature Freezer**  
*Uncompromised Protection for your Samples*

Model: UUS-714B

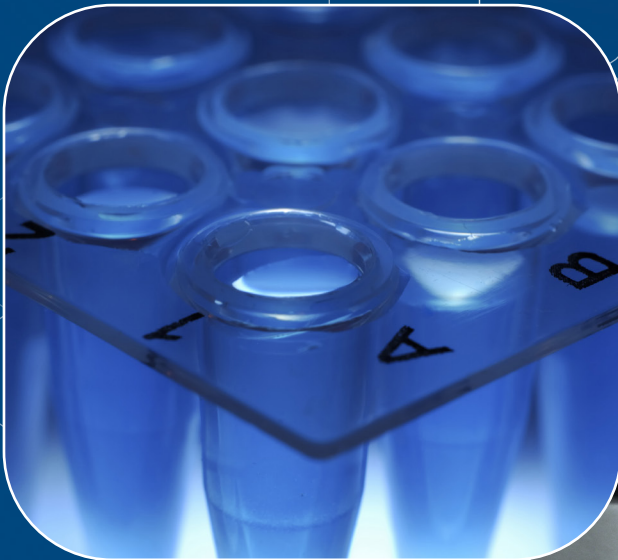

Designed in the USA



# Welcome to Esco Lifesciences

Esco Lifesciences' vision is to provide enabling technologies for scientific discoveries to make human lives healthier and safer.

Esco Lifesciences is committed to delivering innovative solutions for the clinical, life sciences, research, industrial, laboratory, pharmaceutical, and IVF communities. With the most extensive product line in the industry, Esco has passed a number of international standards and certifications. Esco Lifesciences represents innovation and forward-thinking designs, that are of the highest standard quality since 1978.

**Availability and Accessibility.** Esco Lifesciences has headquarters in Singapore, Indonesia, and Philippines, with manufacturing facilities located in Asia and Europe. Research and Development (R&D) is conducted worldwide spanning the US, Europe and Asia. Sales, services, and marketing subsidiaries are located in 42 major markets including US, UK, Japan, China and India. Esco regional distribution centers are located in Singapore, Malaysia, Thailand, Vietnam, Myanmar, Indonesia, Philippines, Bangladesh, Hong Kong, Taiwan, South Korea, China, Japan, India, UAE, Central and South Africa, Denmark, Germany, Italy, Lithuania, Russia, United Kingdom, and USA. Because of our worldwide presence, you can be sure that Esco is within your reach.

**High Quality, Reliable, and Dependable.** Esco Lifesciences products are of high quality, reliable, and dependable. Cross-functional teams from Esco Production, R&D, Quality Assurance, and Senior Management, are regularly assembled to review and implement areas for improvement.

**Esco Lifesciences Cares for Your Safety.** Esco Lifesciences focuses on providing safety not just for your samples, but also for you and the environment.

**Esco Lifesciences Cares for Your Comfort.** Building ergonomic designs and reducing noise levels of the units ensure comfort for our users.

**Esco Lifesciences Cares for the Environment.** Esco Lifesciences incorporates the latest proven technologically advanced components available. One in every four of Esco's employees is involved in Research and Development and are evaluating new components or designs for better efficiency. Whenever a new technology is available, Esco Lifesciences redesigns technology into our new products that will use lesser energy.

**Customer Service and Support.** Our service does not stop once purchase has been done. Esco Lifesciences gives on-time customer service such as service training, preventive maintenance, and re-certification, to respond to your equipment needs. Esco Lifesciences also offers free end-user seminars and provides educational materials and informative videos.

As Esco Lifesciences takes the opportunity to respond to the world's needs, we aim not only to contribute to the advancement of scientific discoveries but also in making the world a safer, healthier, and better place to live in.



# Products and Applications

## Life Sciences Laboratory Equipment

### Sample Preparation

- Class I Biological Safety Cabinets
- Class II Biological Safety Cabinets
- Class II Type A2 Biological Safety Cabinets
- Class II Type B1 Biological Safety Cabinets
- Class II Type B2 Biological Safety Cabinets
- Class III Biological Safety Cabinets
- Horizontal Laminar Flow Cabinets
- Vertical Laminar Flow Cabinets
- Laboratory Animal Research Workstations
- Laboratory Centrifuges

### Sample Cultivation

- CO<sub>2</sub> Incubators, Direct Heat Air-Jacketed
- CO<sub>2</sub> Incubators with Cooling System
- CO<sub>2</sub> Incubators with Stainless Steel Exterior
- Laboratory Shakers

### Sample Handling and Analysis

- PCR Thermal Cyclers
- Conventional Thermal Cyclers
- PCR Sample Handling
- Microplate Shakers
- PCR Cabinets

### Sample Storage & Sample Protection Solutions

- Ultra-low Temperature Freezers
- Lab Refrigerators and Freezers
- Remote Monitoring, Datalogging, and Programming Software
- Intelligent Remote Monitoring Application Protocol
- Wireless Monitoring System

### Chemical Research

- Ductless Fume Hoods
- Laboratory Fume Hoods
- Fume Hood Airflow Monitors
- Exhaust Blowers
- Powder Weighing Balance Enclosures
- Filtered Storage Cabinet

### General Equipment

#### Laboratory Thermostatic Products

- Laboratory Oven
- Forced Convection Laboratory Incubator
- Natural Convection Laboratory Incubator
- Refrigerated Incubator

### Forensic Sciences

- Evidence Drying Cabinet

## Medical / IVF Equipment

### Sample Handling

- Multi-zone ART Workstation (MAW)
- Multi-zone ART Workstation (MAW) Class II
- Airstream® Laminar Flow Bench
- AVT Anti-Vibration Table

- Versati™ Tabletop Centrifuge Refrigerated

### Embryo Culture

- MIRI® Multiroom Incubator
- MIRI® II-12 Multiroom Incubator
- Mini MIRI® Dry Incubator
- Mini MIRI® Humidity Incubator
- CelCulture® CO<sub>2</sub> Incubator

### Innovative Time-Lapse Imaging

- MIRI® Time-lapse Incubator

### Accurate Quality Control

- MIRI® GA Gas and Temperature Validation Unit

### Unique Consumables

- CultureCoin®

## Healthcare

### Esco Pharma Products

#### Airflow Containment Products

- Pharmacon® Downflow Booths
- Ceiling Laminar Airflow Units
- Laminar Flow Horizontal/Vertical Trolley
- Enterprise™ Laminar Flow Straddle Unites
- Cytoculture™ Cytotoxic Safety Cabinets

#### Isolation Containment

- Aseptic Containment Isolator (ACTI)
- Weighing and Dispensing Containment Isolator (WDCI)
- General Processing Platform Isolator (GPPI)
- Containment Barrier Isolator (CBI)
- Turbulent Flow Aseptic (Grade A) Isolator (TFAI)
- Isoclean® Healthcare Platform Isolator (HPI)
- Streamline® Compounding Isolators (SCI)
- Technetium Dispensing Isolators
- Blood Cell Labeling Isolators
- Open and Closed Restricted Barrier Access Systems (RABS)

#### Cross Contamination Facility Integrated Barrier

- BioPass™ Pass Through
- Infinity® Air Shower Pass Box
- Cleanroom Air Shower
- Infinity® Cleanroom Transfer Hatch
- Infinity® Pass Box
- Soft capsule® Soft Wall Cleanroom
- Dynamic Passboxes and Dynamic Floor Laminar Hatches
- Laminar Flow Storage Cabinet

#### Ventilation Containment

- Ventilated Balance Enclosure

### Esco VacxiCell Products

#### Bioreactors and Fermenters

- CelXrocker™ (CXR)
- CelCradle™ (CC)
- CelCradle X® (CCX)
- TideXcell® (TXL)
- VXL™ Hybrid
- BioXcell®
- StirCradle™
- StirCradle™ PRO

#### Harvesting System

- CelShaker™
- CelCradle X® Semi-automated Harvester (CCX-SAH)
- TideXcell Harvester System (TXLHS)

#### Cell Culture Monitoring, Media and Consumables

- Super Plus™
- Plus™ Vero
- Plus™ MDCK
- Plus™ MDCK II
- BioNOC™ II macrocarriers
- BioMESH® macrocarriers
- GlucCell™ Glucose Monitoring System
- Crystal Violet Dye (CVD) Nuclear Count Kit

#### Filling Line Equipment

- Traditional Filling Line

#### Integrated Solutions

- Cell Processing Isolator
- Cell Processing Center

### Esco TaPestle Rx Products and Services

#### Pharmacy Automation and Compounding Supply

- Compounding Pharmacy Isolators (SCI, HPI, CBI, GPPI)
- Safety Cabinets and Enclosures (Class II BSC, VBE, LFC)
- Aseptic Filling Systems

#### Radiopharmacy Equipment

- Radioisotope Fume Hood
- Lead-lined Biosafety Cabinet
- Technetium Dispensing Isolator
- Blood Cell Labeling Isolator
- GMP-compliant Radioisotope Dispensing Isolator



## INTRODUCTION

Ultra-Low Temperature (ULT) Freezers are widely used in scientific research for long-term storage of samples. As ULT freezers are often operated at  $-80^{\circ}\text{C}$  continuously for years, reliability is of paramount importance to the researchers.

Constructed from high-quality proven components with energy-efficient refrigeration design, Esco Lexicon® II ULT freezers provide top notch protection that can withstand the test of time to guarantee the integrity of your samples.



## SAMPLE PORT

- 1" (25mm) diameter for easy access through wall
- Easy external monitoring port for redundant monitoring system
- 2 sample port configuration by default
- Optimally placed on top of the cabinet to eliminate thermal risk to your samples



## EXCELLENT DOOR SEALS

- Triple gasket seal provides maximum protection against thermal intrusion.



## 3 OR 5 INDIVIDUAL INNER DOOR

- 3 or 5 individual inner doors can be opened independently to minimize sample exposure
- Inner door slip-joint hinge design allows easy door dismantling during maintenance and cleaning
- Compatible with existing racking system from competitors
- Magnetic door contact for rapid closure



## MODERN REFRIGERATION COMPONENTS

- High-performance reliable compressors
- System is optimized to provide maximum efficiency in even the most extreme ambient conditions





### GOLD CONTROLLER

- Simple, intuitive operation
- Large display of actual temperature with a simultaneous display of set temperature and ambient temperature
- USB interface allows transfer of temperature data and the last 20 system events
- Includes Automatic Voltage Regulator that maintains a constant voltage level and protects critical freezer components. Additional sample protection!

### PRESSURE EQUALIZATION PORT (PEP)

- Heated port with spring-assisted mechanism to prevent icing on the vent
- Allows the freezer door to be opened shortly after adding samples
- Located on the main door for easy cleaning

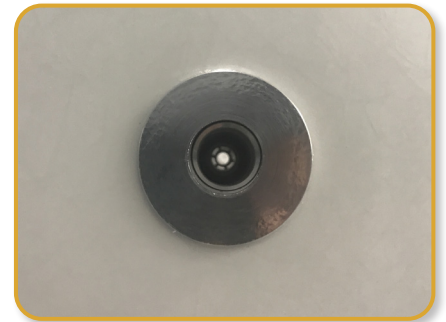

### OPTIONAL CHART RECORDER

- Front-mounted
- For independent temperature monitoring
- Provides permanent record of thermal performance



### ISOCIDE™ POWDER COAT

- Silver-ion impregnated powder coat
- Inhibits microbial growth to improve safety

UUS-714B-1, 230 VAC, 50 Hz

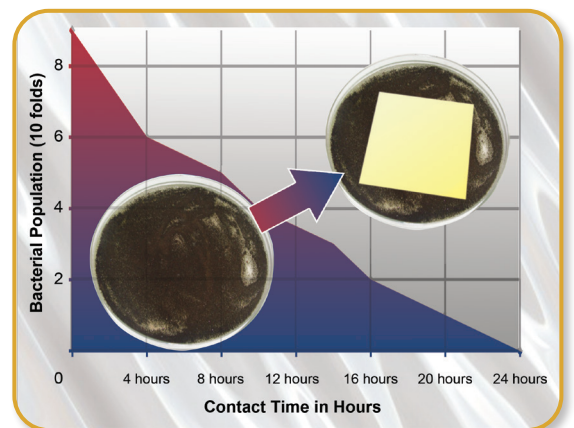

## ENGINEERING EXCELLENCE & STRICT PROCESS CONTROL

- Strict evacuation protocols and process controls to ensure a clean, dry, and leak-free system
- Climate controlled assembly area to eliminate particulates and maintain a constant ambient temperature
- Computer controlled foaming machine to eliminate foaming variables
- Advanced data logging system to ensure all units are tested and analyzed properly and documented
- In-house designed and developed evacuation and charging process equipment specifically designed for the manufacture of ultra-low cascade refrigeration systems

## EXCEPTIONAL RELIABILITY

Accelerated Life Test at 40°C to 43°C Ambient

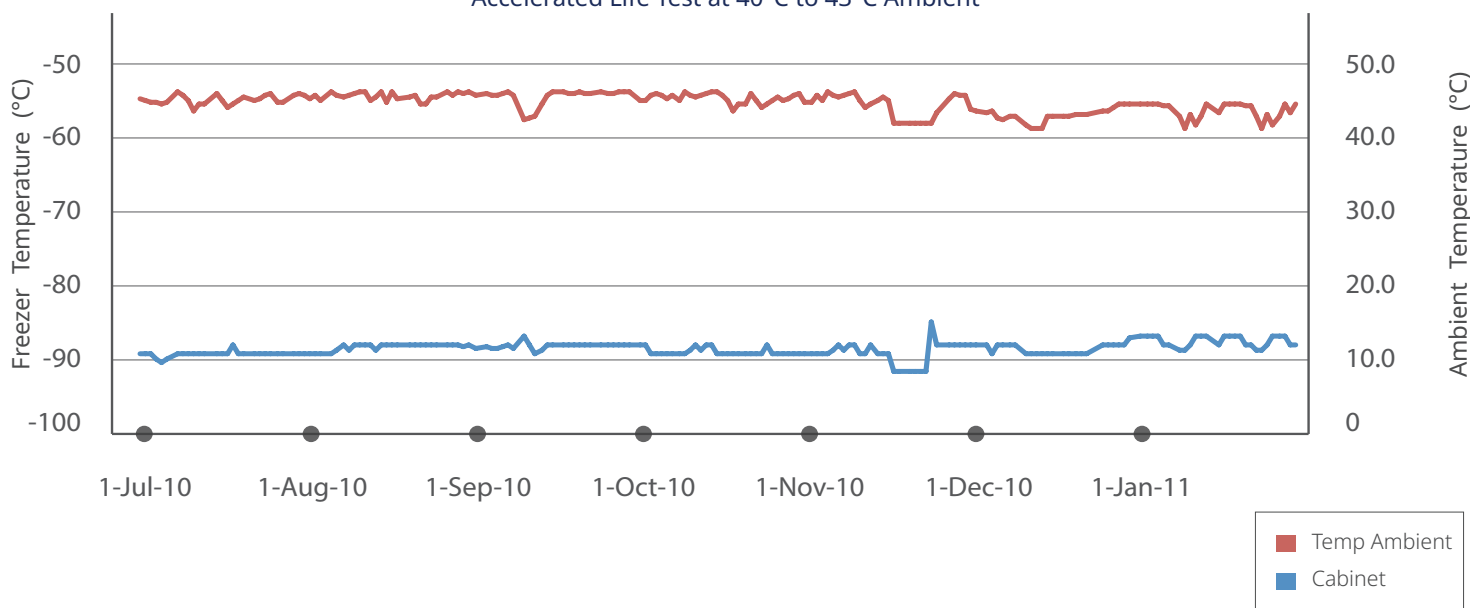

**Esco has used industry-accepted Highly Accelerated Life Testing (HALT) to stress test a large number of Lexicon Freezers at extreme conditions. The Lexicon freezers passed these extreme stress tests insuring a design that is optimized to protect your precious samples.**

In accordance with ANSI/ASHRAE 72-2005 and ARI 1200-2006/2008

guidelines and as tested by a UL validated third party test lab, DNS USA, the Esco Lexicon ULT Freezer surpassed the performance of 5 major competitors with lower energy consumption, superior cabinet performance (as measured by warm-up time), and demonstrated a larger BTU refrigeration reserve capacity.

*Superior performance, lower energy costs, better protection.*

## QUALITY COMPONENTS

**All freezer components were selected from many tear-down and comparison tests. Only the most reliable components were selected.**

- Danfoss® compressors are reliable and have high performance.
- Danfoss® filter drier is optimized for HFC refrigerants and uses 100% 3Å molecular sieve core for high moisture drying capacity. (Moisture equates to clogs in the system!).
- Condenser is oversized by design to provide a greater capacity for cooling.

- Condenser fans generate high airflow and have quiet operation.
- Energy-efficient high performance oil separator eliminates solid contaminants along with excess oil from the system and enhances the entire system's performance.
- One seamless full wrap copper evaporator tube with no joints reduces any possibility of leaks in the field.
- Highly efficient corrosion resistant and pressure resistant heat exchanger used for maximum heat transfer.

## LOW ENERGY CONSUMPTION

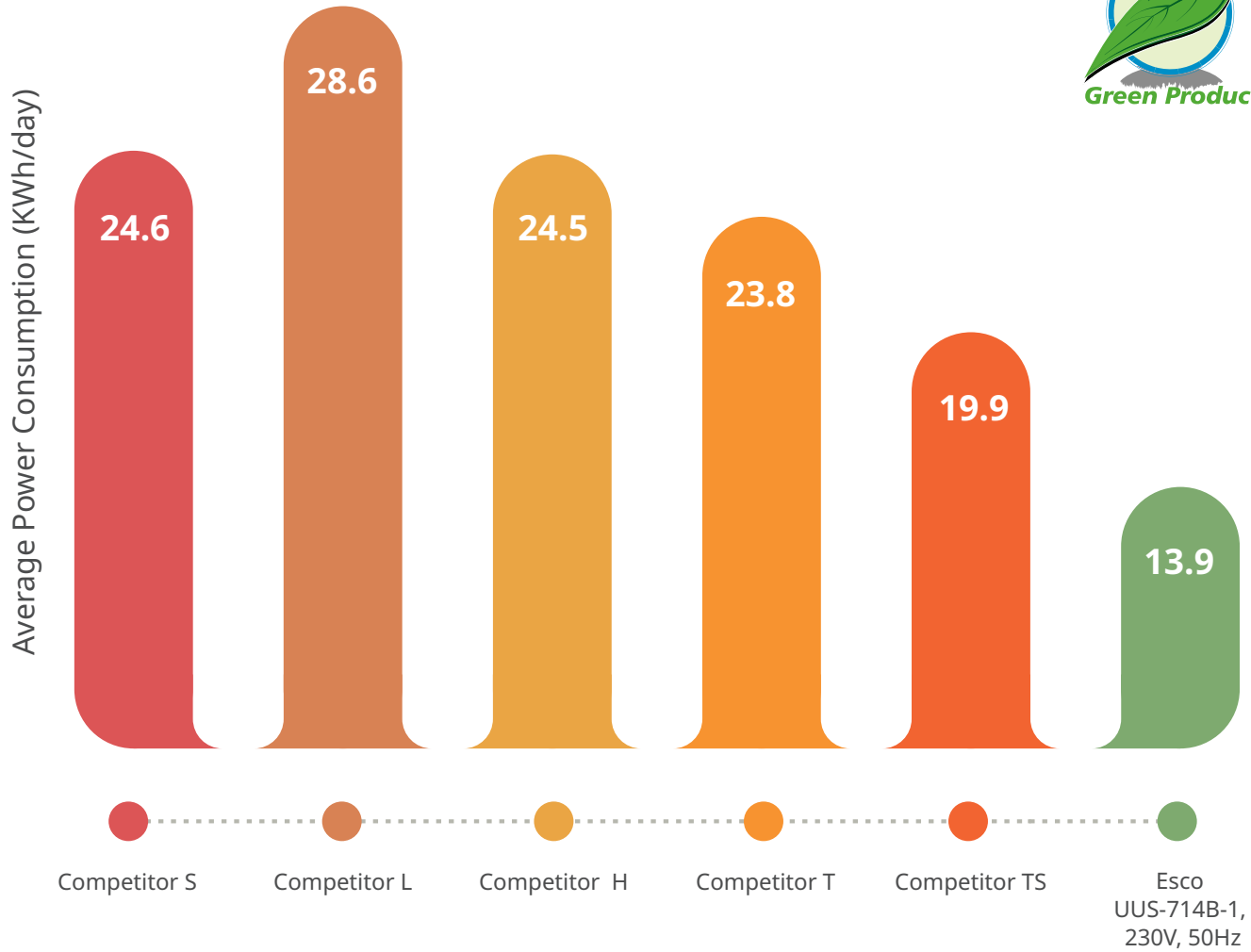

Energy Consumption (KWh/day) at  $T_{set} = -80^{\circ}\text{C}$

Esco UUS-714B-1-SS or UUS-714B-1 energy usage (KWh/day)	13.9
Estimated conventional freezer energy usage (KWh/day)	24.3
10-year energy cost savings over conventional freezer in USD (based on 0.10\$/KWh)	3,099
10-year carbon footprint reduction over conventional freezer in kg CO <sub>2</sub> (0.58 kg CO <sub>2</sub> /KWh)	17,973

*Esco energy consumption is the lowest of all manufacturers' conventional ULT freezers of similar size compared above.*

## LOW HEAT EMISSION TO AMBIENT

Esco UUS-714B-1 Heat Emission to lab space (KW)	0.78
Estimated conventional freezer heat emission (KW)	0.92
Less amount of heat emitted that needs to be removed by air-conditioner in the lab space (KWh/Day)	3.2
10-year energy cost savings over conventional freezer in USD (based on 0.10\$/KWh)	1165.1

- Less heat emission than conventional ULT freezers of similar size.
- Substantial savings on air-conditioning costs.

## ENVIRONMENT-FRIENDLY



- Only environmentally friendly CFC-free and HCFC-free HFC refrigerants are used.
- HFC and HC refrigerants (R-404A, R-508B and R290).
- CFC and HCFC compounds have high impact on the ozone in the Earth's atmosphere, whereas HFC does not contain chlorine and is not harmful to the earth's atmosphere.
- Biodegradable, high-performance synthetic polyolester oil, and CFC-free blowing agent are used.

# SUPERIOR SAMPLE PROTECTION

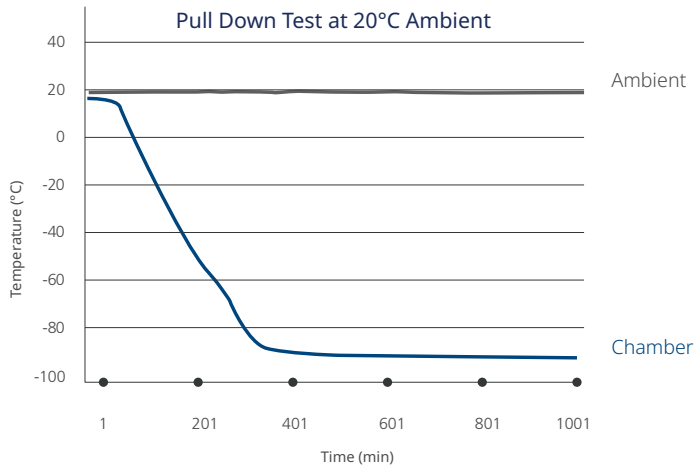

## FAST PULL DOWN

- Pull down time is the time required to bring down the temperature of the ULT freezer from ambient to the set temperature.
- Esco Lexicon® II has a short pull down time which signifies an efficient refrigeration system.

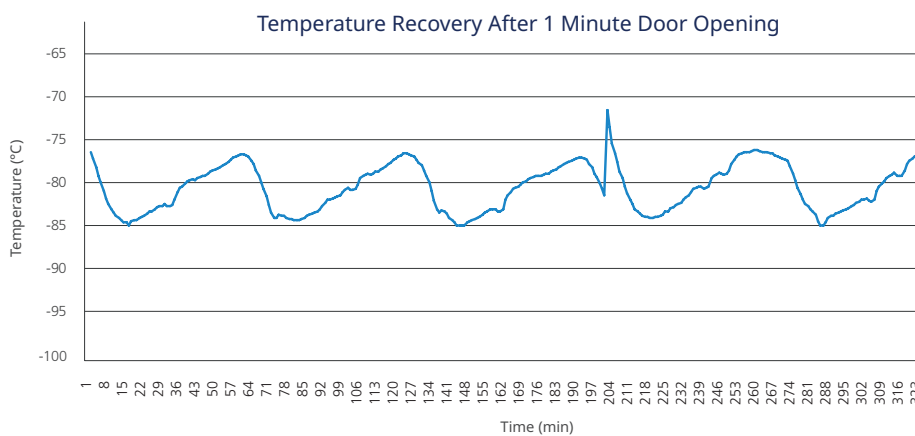

## FAST TEMPERATURE RECOVERY AFTER DOOR OPENING

- Esco Lexicon® II recovers temperature in minutes following a 1 minute door opening. Fast recovery in temperature ensures integrity of stored samples.

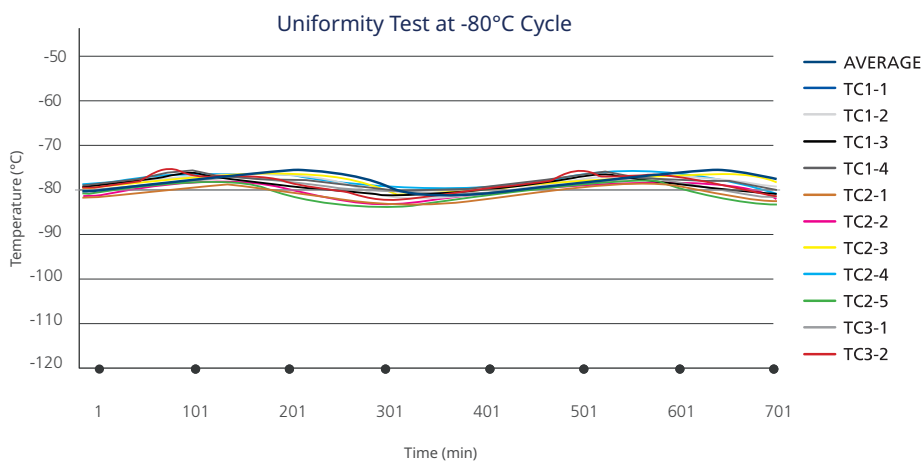

## EXCELLENT UNIFORMITY

- Uniformity test measures the difference between the coldest spot and warmest spot in the freezer chamber when the freezer is operating at set temperature.
- Esco Lexicon® II has excellent uniformity under normal operating conditions. This guarantees that all samples are at the correct temperature.

## EXTENDED WARM-UP TIME DURING A POWER FAILURE

- Warm-up time measures the time taken for temperature to rise up (from -80°C to -50°C) when the power is interrupted.
- With a robust insulation system in place, Esco Lexicon® II has the best warm-up time among the freezers compared on the right. Slower warm-up during an extended power failure buys the user time for carrying out a back-up plan.

Warm-up time from -80°C to -50°C

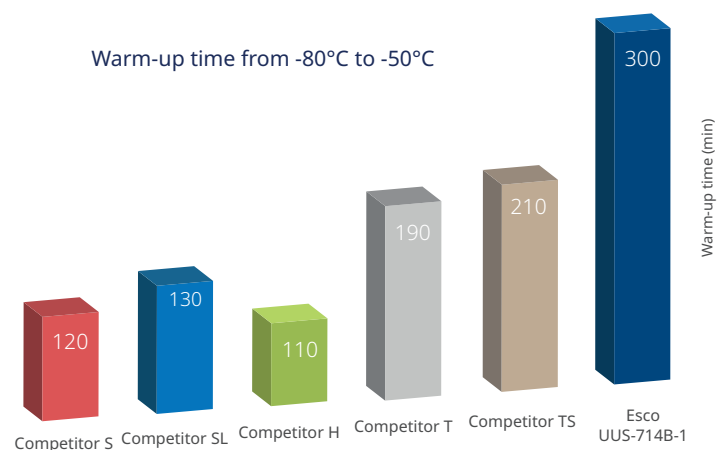



## LARGE RESERVE CAPACITY

- Reserve capacity test records the lowest temperature the freezer is able to sustain when a heat source is placed in the freezer. This resembles real life situations when hot samples are placed in the freezer. The lower the temperature the freezer can sustain, the higher chance the freezer can maintain the set temperature when warm samples are placed in the freezer.
- Esco reserve capacity surpasses that of all major brands tested below.

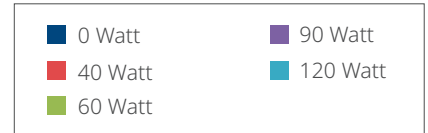

BTU Reserve Average of 16 Probes

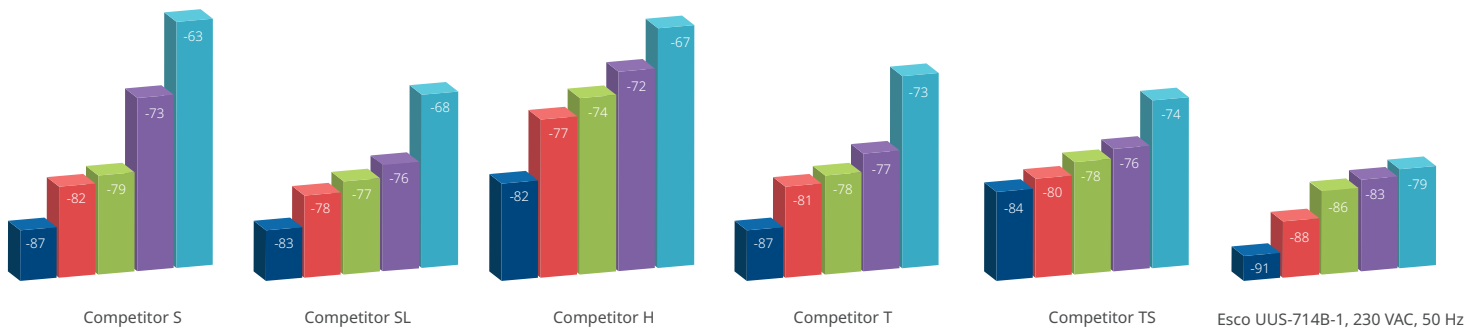

## LOW NOISE OPERATION

- According to OSHA 1910.95 Occupational Noise Exposure Regulation, the sound level of the work place has to fall below 90 dBA for an employee who works 8 hours/day.
- Total noise in a lab is highly dependent upon the equipment that emits the greatest amount of noise.
- Esco Lexicon® II ultra-low freezer has a noise level of approximately 56 dBA. This ensures a quiet and pleasant working environment for lab users.

## EASY TO SERVICE

- Embedded thermocouples in the foam for easy field troubleshooting.
- Filter driers are located at the deck for easy replacement.
- Adjustable main door hinge and latch.
- Condenser filter is conveniently located at the front of the freezer. This allows easy access for inspection, cleaning and/or changing.
- 5-year warranty on compressors, 5 years on complete system.

# TESTING AND CERTIFICATION



The Esco Lexicon Ultra-Low Temperature Freezer is listed by Underwriters Laboratory (UL), to meet the requirements of both the U.S. and Canada standards for electrical/mechanical integrity.



# INTELLIGENT DESIGN

## EFFECTIVE COOLING TECHNOLOGY

HeatRecycler™ Technology allows efficient recycling of the heat generated by the system. This reduces power consumption and prolongs the life of the freezer.

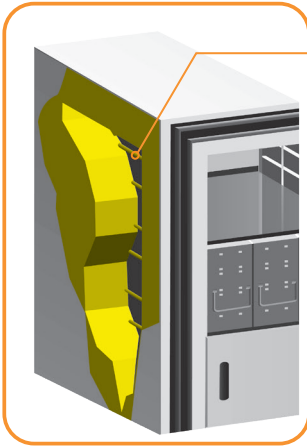

### Mullion Heater

- Two additional “heat exchangers” to channel heat energy.
- “Mullion heater” recycles excess heat from 1st stage compressor to heat up main door gasket. This prevents ice from forming on the gasket and provides easy door closing.

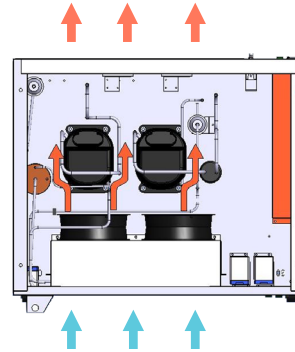

- 2-Stage cascade refrigeration system.
- Two fans are employed to draw consistent airflow from the front to the back of the freezer to cool the condenser.
- Two 1-hp hermetic compressors operated at a low speed for longer life.
- The compressors sit directly behind the fans and are air-cooled for better operating conditions.

## SUPERIOR INSULATION SYSTEM

Maximum product protection is provided by Lexicon's superior insulation system.



Triple gasket seal protects against thermal leaks and prevents frost build-up.



5" thick polyurethane foam is placed in the main cabinet and 4.5" on the door.

## QUICKOPEN™ FAST DOOR RE-OPEN SYSTEM

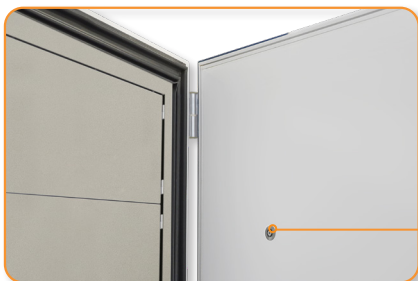

Esco designed Pressure Equalization Port (PEP) to relieve the vacuum that is formed inside the chamber after door opening. PEP is temperature-controlled to prevent ice formation on the port.

Pressure Equalization Port (PEP)



Ergonomically designed door handle allows one-handed door opening.



Esco Lexicon® II ULTF comes with an Automatic Voltage Regulator to maintain a constant voltage level and minimize fluctuations for stability as it runs continuously.

- AVR Power: 5kVA
- Circuit Breaker: 32 Amps

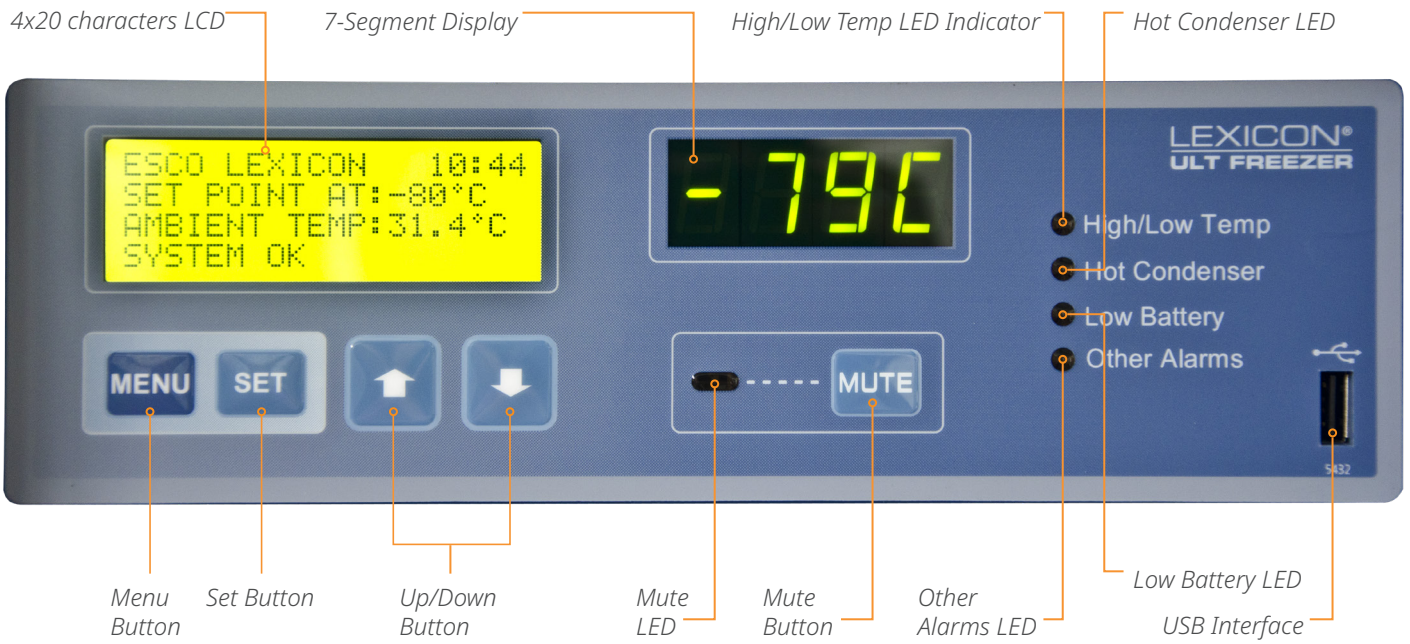

### GOLD CONTROLLER - a powerful controller with more advanced features

- Simple, intuitive operation
- Large display of actual temperature with a simultaneous display of set temperature and ambient temperature
- USB interface allows transfer of temperature data and the last 20 system events
- Includes Automatic Voltage Regulator that maintains a constant voltage level and protects critical freezer components. Additional sample protection!

GUIDE TO MODELS														
<u>UUS-363B-1-5D-SS</u>														
MODEL	Code	TYPE	Code	UNIT	Code	SIZE	Code	CONTROLLER	Code	ELECTRICAL RATING	Code	INTERNAL DOOR	Code	TYPE
Ultra-Low Temperature Freezer	U	Upright	U	Standard	S	363 L (13 cu. ft.)	363	Gold	B	220-240 VAC, 50 Hz	1	3 Internal Door Configuration		Stainless Steel
						480 L (17 cu. ft.)	480			220-240 VAC, 60 Hz	3	5 Internal Doors Configuration	5D	
						597 L (21 cu. ft.)	597							
						714 L (25 cu. ft.)	714							

# GENERAL SPECIFICATIONS

## ULTRA-LOW TEMPERATURE FREEZERS

	UUS-363B-1-SS (2180055)	UUS-480B-1-SS (2180056)	UUS-597B-1-SS (2180057)	UUS-714B-1-SS (2180058)
	UUS-363B-1-5D-SS (2180059)	UUS-480B-1-5D-SS (2180060)	UUS-597B-1-5D-SS (2180061)	UUS-714B-1-5D-SS (2180062)
	UUS-363B-3-SS (2180067)	UUS-480B-3-SS (2180068)	UUS-597B-3-SS (2180069)	UUS-714B-3-SS (2180070)
	UUS-363B-3-5D-SS (2180079)	UUS-480B-3-5D-SS (2180080)	UUS-597B-3-5D-SS (2180081)	UUS-714B-3-5D-SS (2180082)
Temperature Range	-50 to -86 °C			
Ambient Temperature Range	15 to 32°C (59 to 90 °F)			
Capacity	363 L (12.8 ft <sup>3</sup> )	480 L (16.9 ft <sup>3</sup> )	597 L (21.1 ft <sup>3</sup> )	714 L (25.2 ft <sup>3</sup> )
Energy Consumption	Approx. 10.08 kWh/day	Approx. 11 kWh/day	Approx. 11.52 kWh/day	Approx. 13.92 kWh/day
Heat Emission	0.64 kW	0.67 kW	0.71 kW	0.78 kW
Pull Down Time in Minutes (from amb to -80°C)	276	347	353	473
Temperature Recovery Time After 1 Minute Door Opening	24 minutes	36 minutes	36 minutes	36 minutes
Average Uniformity of Cycle (-80°C)	8-9°C	7 °C	7 °C	7 °C
Warm-up Time from -80°C to -50°C (Minutes)	199	260	261	300
Reserve Capacity at 0 Watt	-87.1	-89.2	-87.8	-91
Reserve Capacity at 40 Watts	-85.1	-86.5	-85.8	-88
Reserve Capacity at 60 Watts	-82.8	-80.9	-83.1	-86
Reserve Capacity at 90 Watts	-77.9	-77.5	-80.1	-83
Reserve Capacity at 120 Watts	-73.2	-74.2	-76.4	-79
Noise Level in dBA	55.9	56.3	56.1	59.1
External Dimensions (W x D x H) <i>*refer to engineering drawing on page 13 for detail dimensions</i>	797 x 1060 x 1984 mm (31.4" x 41.7" x 78.1")	942 x 1060 x 1984 mm (37" x 41.7" x 78.1")	1087 x 1060 x 1984 mm (42.8" x 41.7" x 78.1")	1232 x 1060 x 1984 mm (48.5" x 41.7" x 78.1")
Internal Dimensions (W x D x H) <i>*refer to usable storage space inside the unit</i>	450 x 620 x 1300 mm (17.7" x 24.4" x 51.2")	595 x 620 x 1300 mm (23.4" x 24.4" x 51.2")	740 x 620 x 1300 mm (29.1" x 24.4" x 51.2")	885 x 620 x 1300 mm (34.8" x 24.4" x 51.2")
Electrical Rating	12/13 A, 230 VAC, 50 Hz, 1Ø 12/13 A, 230 VAC, 60 Hz, 1Ø	12/13 A, 230 VAC, 50 Hz, 1Ø 12/13 A, 230 VAC, 60 Hz, 1Ø	12/13 A, 230 VAC, 50 Hz, 1Ø 12/13 A, 230 VAC, 60 Hz, 1Ø	12/13 A, 230 VAC, 50 Hz, 1Ø 12/13 A, 230 VAC, 60 Hz, 1Ø
Number of Outer Door	1			
Number of Inner Doors	3 or 5			
Number of Storage Racks per Shelf	3	4	5	6
Number of Storage Racks per Unit	9 or 15	12 or 20	15 or 25	18 or 30
Storage Box Capacities for 2" Cardboard Boxes (with 3 inner doors)	252	336	420	504
Storage Box Capacities for 3" Cardboard Boxes (with 3 Inner Doors)	180	240	300	360
Storage Box Capacities for 2" Cardboard Boxes (with 5 Inner Doors)	240	320	400	480
Storage Box Capacities for 3" Cardboard Boxes (with 5 Inner Doors)	180	240	300	360
Shelves Material	SS304 0.9 mm thickness			SS304 1.2 mm thickness
Shelves Area	438 x 570 mm (17.2" x 22.4")	583 x 570 mm (22.9" x 22.4")	728 x 570 mm (28.6" x 22.4")	873 x 570 mm (34.4" x 22.4")
Maximum Load per Shelf	50 Kg (110 lbs) per shelf		90 Kg (198 lbs) per shelf	
Maximum number of shelves per unit	6			
Net Weight	277 Kg (610 lbs)	304 Kg (670 lbs)	326 Kg (718 lbs)	360 Kg (793 lbs)
Shipping Weight	329 Kg (725 lbs)	362 Kg (798 lbs)	388 Kg (855 lbs)	428 Kg (943 lbs)
Shipping Dimensions (W x D x H)	891 x 1000 x 2143 mm (35" x 39.3" x 84.3")	1036 x 1000 x 2143 mm (40.7" x 39.3" x 84.3")	1100 x 1050 x 2143 mm (43.3" x 41.3" x 84.3")	1256 x 1050 x 2143 mm (49.4" x 41.3" x 84.3")

## ENGINEERING DRAWING

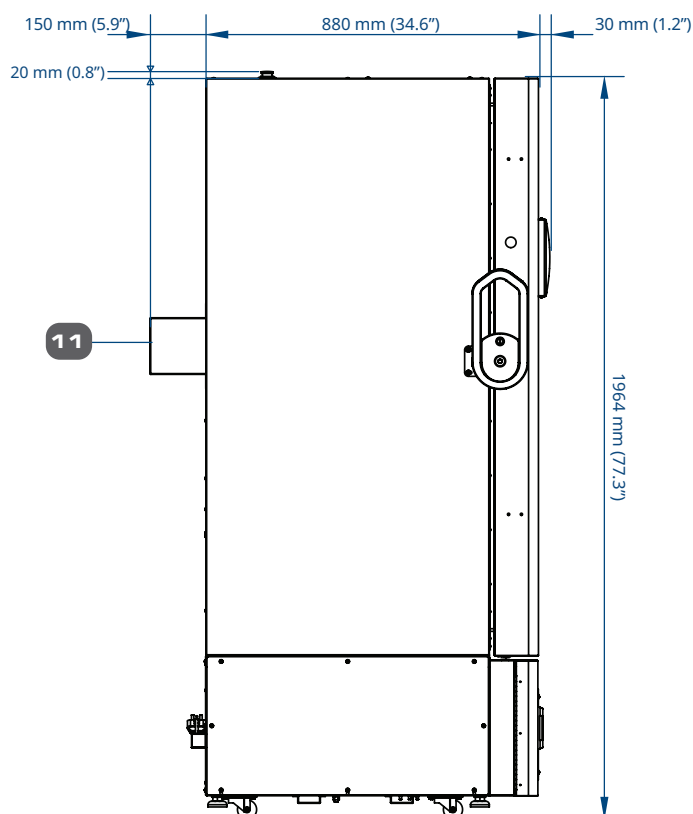
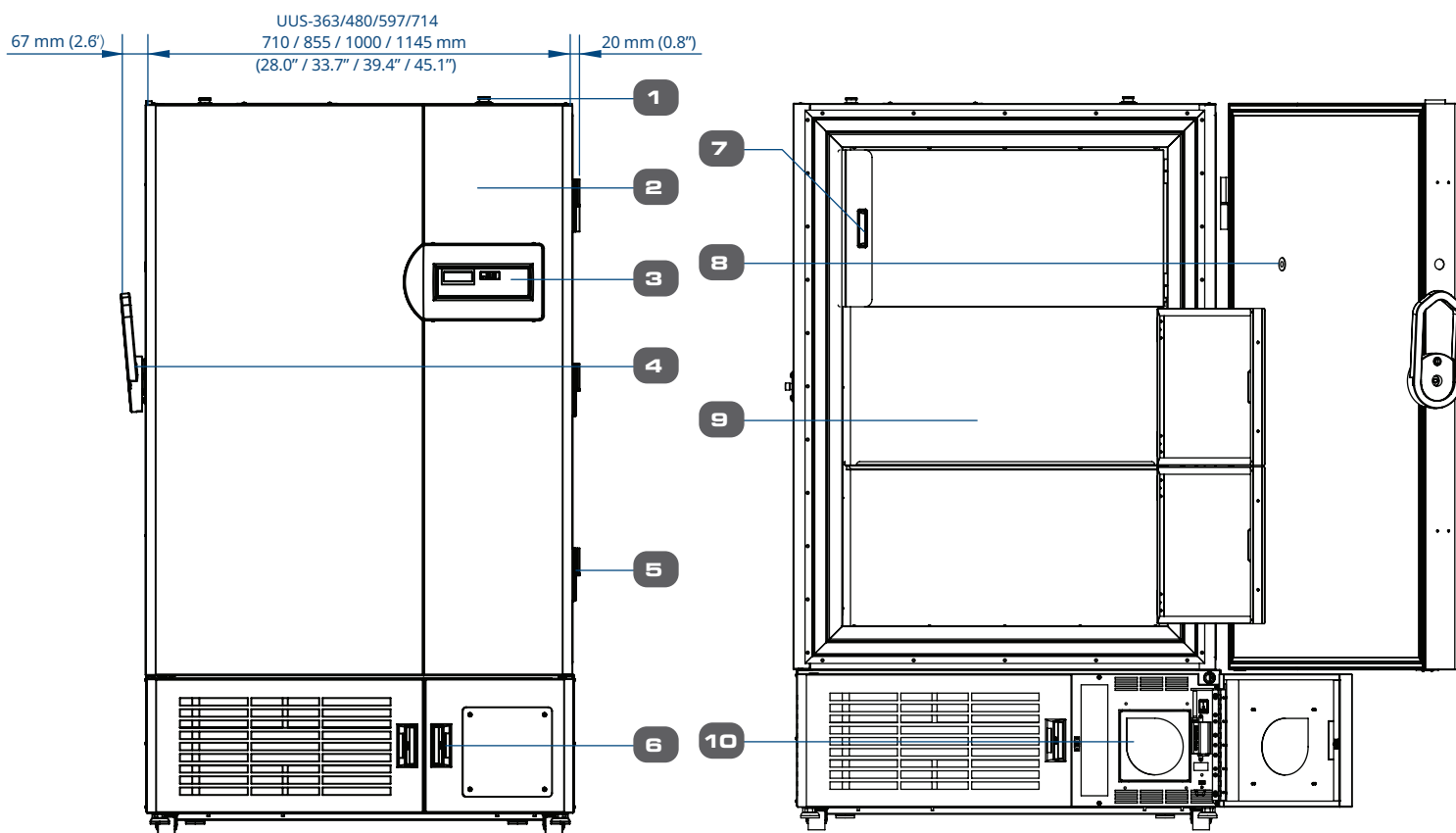

1. Access Port
2. Main Door
3. Control Panel
4. Main Door Handle
5. Main Door Hinge
6. Condenser Filter Door
7. Embedded Pulls
8. PEP Port
9. Inner Door (3/5 configuration depends on the model)
10. Optional Chart Recorder Box
11. Omega Bracket (uninstalled during shipment)

NOTE: Only for UUS-363, the bottom door has a single door.  
Dimensions:  $\pm 10$  mm

## ORDERING INFORMATION

MODELS		DESCRIPTION
230 VAC, 50 Hz	230 VAC, 60 Hz	LEXICON® II GOLD CONTROLLER WITH STANDARD SS CHAMBER WITH 3 INNER DOORS
UUS-363B-1-SS (2180055)	UUS-363B-3-SS (2180067)	Ultra-Low temperature Freezer; Upright; 13 ft <sup>3</sup> (363 L)
UUS-480B-1-SS (2180056)	UUS-480B-3-SS (2180068)	Ultra-Low temperature Freezer; Upright; 17 ft <sup>3</sup> (480 L)
UUS-597B-1-SS (2180057)	UUS-597B-3-SS (2180069)	Ultra-Low temperature Freezer; Upright; 21 ft <sup>3</sup> (597 L)
UUS-714B-1-SS (2180058)	UUS-714B-3-SS (2180070)	Ultra-Low temperature Freezer; Upright; 25 ft <sup>3</sup> (714 L)

MODELS		DESCRIPTION
230 VAC, 50 Hz	230 VAC, 60 Hz	LEXICON® II GOLD CONTROLLER WITH STANDARD SS CHAMBER WITH 5 INNER DOORS
UUS-363B-1-5D-SS (2180059)	UUS-363B-3-5D-SS (2180079)	Ultra-Low temperature Freezer; Upright; 13 ft <sup>3</sup> (363 L)
UUS-480B-1-5D-SS (2180060)	UUS-480B-3-5D-SS (2180080)	Ultra-Low temperature Freezer; Upright; 17 ft <sup>3</sup> (480 L)
UUS-597B-1-5D-SS (2180061)	UUS-597B-3-5D-SS (2180081)	Ultra-Low temperature Freezer; Upright; 21 ft <sup>3</sup> (597 L)
UUS-714B-1-5D-SS (2180062)	UUS-714B-3-5D-SS (2180082)	Ultra-Low temperature Freezer; Upright; 25 ft <sup>3</sup> (714 L)

ACCESSORIES	DESCRIPTION
5075345	Recorder Kit (Chart recorder, 7-day chart paper, pens, universal outlet)
5070901	Additional Shelving Kit for 363 L
5070902	Additional Shelving Kit for 480 L
5070903	Additional Shelving Kit for 597 L
5070904	Additional Shelving Kit for 714 L
1180061	Standard Cardboard 2-inch Box
1180062	Standard Cardboard 3-inch Box
1180063	Standard Cardboard 100-Cell Divider
1180064	Standard Cardboard 81-Cell Divider
1180065	Standard Cardboard 64-Cell Divider
1180066	Standard Cardboard 49-Cell Divider
5170527	Modifiable Clip Rack with 3 inner door configuration
5170526	Modifiable Clip Rack with 5 inner door configuration
5170644	3" Drawer Rack with 3 inner door configuration
5170647	3" Drawer Rack with 5 inner door configuration
5170645	2" Drawer Rack with 3 inner door configuration
5170646	2" Drawer Rack with 5 inner door configuration
5170438	LCO <sub>2</sub> back-up system
1260040	Ice Scraper
1260039	Cryo Safety Gloves
9010101	IQ/OQ Documentation
5250001	Voyager® Software Kit with iRMAP (Intelligent Remote Monitoring Application Protocol)
1260110	6" Temperature Chart, 7day, 60/pack
1260111	Chart Recorder Pen Replacement 6 pens/pack
(see PROtect Gen 2 brochure)	PROtect Gen 2
1120240	SMS Module System

## OPTIONS AND ACCESSORIES



### Chart Recorder Kit (1081733)

The chart recorder provides an easy-to-read graph of data vs time. It is a reliable, accurate, and stable instrument, for on-the-spot written documentation of freezer chamber temperature. This model offers a 6" chart of temperature data.

Kit includes the 6" temperature chart recorder, 1 pack pen replacement, 1 pack 7-day paper and universal outlet.

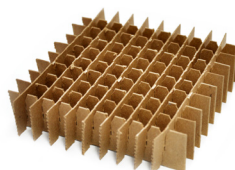

### Standard Cardboard 100-cell Divider (1180063)

100-cell Dividers are made of 10 x 10, 7/16" cells and each divider holds 100 (12 mm wide vials).

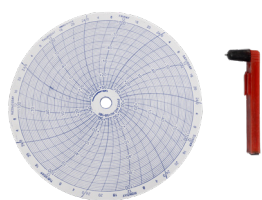

### Temperature Chart and Pen Replacements for 6" Chart Recorder

- 6" Temperature Chart, 7day, 60/pack (1260110)
- Chart Recorder Pen Replacement 6pens/pack (1260111)

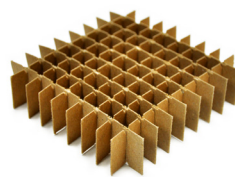

### Standard Cardboard 81-cell Divider (1180064)

81-cell Dividers are made of 9 x 9, 1/4" cells and each divider holds 81 (13 mm wide vials).



### Standard Cardboard 2-inch Box (1180061)

Fiberboard boxes have the dimension of 130 x 130 x 50 mm (5.25" x 5.25" x 2"). All boxes do not come with dividers. Dividers have to be ordered separately.

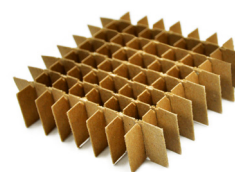

### Standard Cardboard 64-cell Divider (1180065)

64-cell Dividers are made of 8 x 8, 9/16" cells and each divider holds 64 (14 mm wide vials).



### Standard Cardboard 3-inch Box (1180062)

Fiberboard boxes have the dimension of 130 x 130 x 80 mm (5.25" x 5.25" x 3"). All boxes do not come with dividers. Dividers have to be ordered separately.

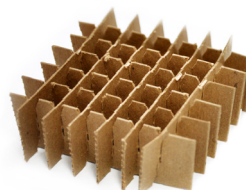

### Standard Cardboard 49-cell Divider (1180066)

49-cell Dividers are made of 7 x 7, 5/8" cells and each divider holds 49 (16 mm wide vials).



### Additional Shelving Kit UUS-363 (5070901), UUS-480 (5070902) UUS-597 (5070903), UUS-714 (5070904)

Each Lexicon® II ULT freezer comes standard with 2 shelves, 8 clips for *three inner doors* and 4 shelves, 16 clips for *five inner doors*.

Extra shelves are available and each shelf comes with 4 clips.



### SMS Module System

GPRS/GSM Modem accessory for SMS Alerts on Esco Lexicon® ULT freezers. The GPRS/GSM Modem is an optional accessory and is compatible with Lexicon II with Gold and Platinum Controller.



### LCO<sub>2</sub> Back-up System (5170438)

LCO<sub>2</sub> back-up system injects liquid CO<sub>2</sub> on demand when cabinet temperature warms to a pre-set level. Back-up system kits include all hardware except the supply cylinder. In the event of a power failure, the system will operate on a charged battery.

- Display Temp. Range: -40 to -70°C
- Resolution: 1°C
- Dimensions: W x D x H (350 x 384 x 116 mm)
- Audio & visual alarms



### Ice Scraper (1260040)

Ice scraper is available for cleaning ice built up on door gasket, PEP and other places in the freezer.



### Cryo Safety Gloves (1260039)

Mid-arm style cryo safety gloves are available for use with ultra-cold surfaces. Cryo safety gloves protect hands and arm when inserting or removing inventory.



### IQ/OQ Protocol (9010101)

IQ/OQ protocol document is available for verifying that the equipment has been installed in accordance with installation specifications and is functioning and operating at the intended operational parameters.



### Voyager® Software Kit (5250001)

Esco Voyager® is a PC-based software package developed for the remote monitoring, datalogging and programming / device configuration of Esco controlled environment laboratory equipment. Compatible equipment includes Laboratory Ovens and Incubators, Low Temperature Incubator, CO<sub>2</sub> Incubators and Ultra-Low Temperature Freezer



### PROtect Gen 2 - Independent and Redundant Monitoring System

- PROtect Gen 2 has no dependency on the freezer electronics so in the event of a catastrophic failure that would prevent all other systems from notifying the user, PROtect can provide the necessary alerts to protect your irreplaceable samples.
- Multiple installations in remote buildings can be monitored and multiple users can access the system simultaneously.
- The PROtect sensors measure, record, and transmit data measurements via the Esco operator network or a private Esco gateway. Very low power consumption (battery life up to 4 years).
- The sensors are equipped with an internal memory that is able to record up to 10,000 data points.



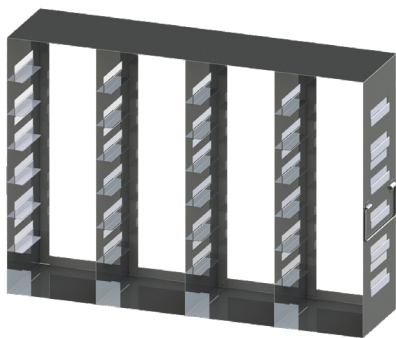

#### **Modifiable Clip rack for Lexicon® II with 3 inner door configuration (5170527)**

- Can fit standard 130 x 130 x 50 mm (5.25" x 5.25" x 2") boxes and/or standard 130 x 130 x 80 mm (5.25" x 5.25" x 3") boxes by changing the position of the clips.
- 28 boxes can be fitted for 2" cardboard box and 20 boxes can be fitted for the 3" cardboard box.
- Made of stainless steel and has handles. Each rack includes 12 L-Clips and 18 T-Clips.
- Size: 137 x 556 x 395 mm (W x D x H)
- Weight: 2.5 Kg

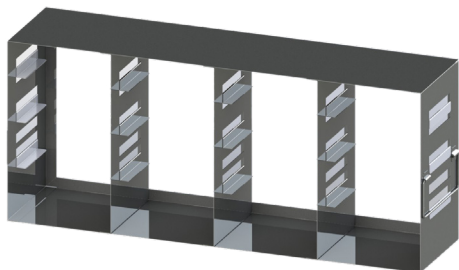

#### **Modifiable Clip rack for Lexicon® II with 5 inner door configuration (5170526)**

- Can fit standard 130 x 130 x 50 mm (5.25" x 5.25" x 2") boxes and/or standard 130 x 130 x 80 mm (5.25" x 5.25" x 3") boxes by changing the position of the clips.
- 16 boxes can be fitted for 2" cardboard box and 12 boxes can be fitted for the 3" cardboard box.
- Made of stainless steel and has handles. Each rack includes 6 L-Clips and 9 T-Clips.
- Size: 137 x 556 x 240 mm (W x D x H)
- Weight: 2 Kg

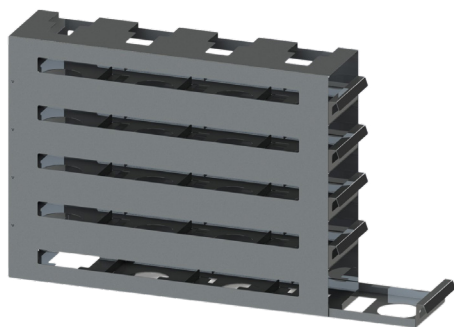

#### **3" Drawer rack for Lexicon® II with 3 inner door configuration (5170644)**

- Can fit standard 130 x 130 x 80 mm (5.25" x 5.25" x 3") boxes
- Has 5 shelves and contain 4 boxes per shelf. (5 x 4 configuration)
- Made of stainless steel and has handles.
- Size: 139 x 551 x 441 mm (W x D x H)
- Weight: 6 Kg

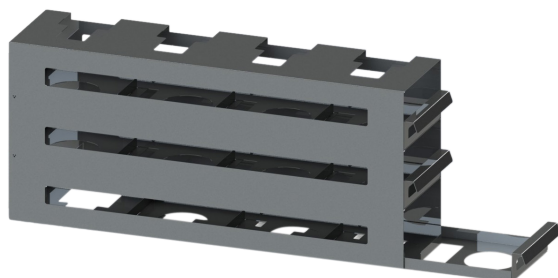

#### **3" Drawer rack for Lexicon® II with 5 inner door configuration (5170647)**

- Can fit standard 130 x 130 x 80 mm (5.25" x 5.25" x 3") boxes
- Has 3 shelves and contain 4 boxes per shelf. (3 x 4 configuration)
- Made of stainless steel and has handles.
- Size: 139 x 551 x 245 mm (W x D x H)
- Weight: 4 Kg

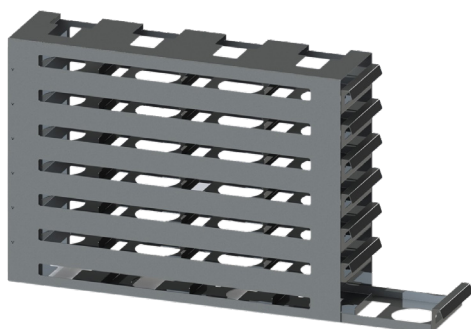

#### **2" Drawer rack for Lexicon® II with 3 inner door configuration (5170645)**

- Can fit standard 130 x 130 x 50 mm (5.25" x 5.25" x 2") boxes
- Has 7 shelves and contain 4 boxes per shelf. (7 x 4 configuration)
- Made of stainless steel and has handles.
- Size: 139 x 551 x 398 mm (W x D x H)
- Weight: 7.5 Kg

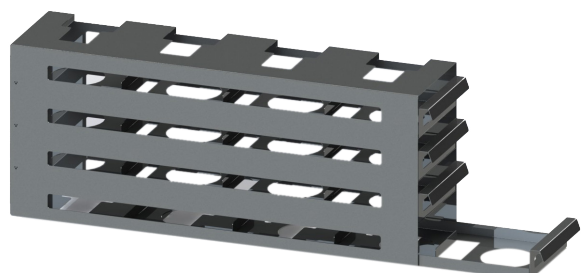

#### **2" Drawer rack for Lexicon® II with 5 inner door configuration (5170646)**

- Can fit standard 130 x 130 x 50 mm (5.25" x 5.25" x 2") boxes
- Has 4 shelves and contain 4 boxes per shelf. (4 x 4 configuration)
- Made of stainless steel and has handles.
- Size: 139 x 551 x 228 mm (W x D x H)
- Weight: 5 Kg

## VOYAGER® SOFTWARE - CENTRAL CONTROL AND MONITORING SYSTEM

### Extra Protection for Your Sample

- Lexicon® II freezers with the controller can communicate with Voyager® via RS485 connection.
- All information is kept securely inside the facility firewall. Once connected, Voyager® can notify users from a central location of any freezer alert or condition that can threaten sample safety or integrity.
- Voyager® can communicate with the available intelligent Remote Monitoring Application Protocol service (iRMAP).

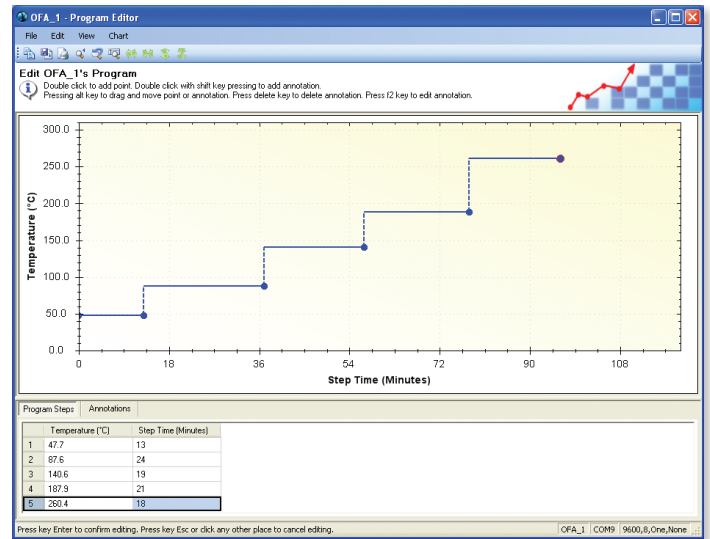

## INTELLIGENT REMOTE MONITORING APPLICATION PROTOCOL (IRMAP) SERVICE

- With iRMAP optional service, Esco will remotely monitor your Esco freezers in case of issues that might threaten your samples, Esco will call the supplied customer contact to provide assistance.
- iRMAP allows Esco to guard your samples 24 hours a day/7 days a week. Esco can even provide proactive service response if the predictive failure monitoring system finds a fault in your Esco freezer.
- If the user elects to transmit data outside of their facility, then Voyager® will encrypt the data twice and allow the freezer data to be monitored by iRMAP services at the Esco monitoring headquarters.
- Users can access Voyager® data logs anytime and at any location using web browser applications. Customer can access and acknowledge alarms and data using apps for iOS and android mobile devices.

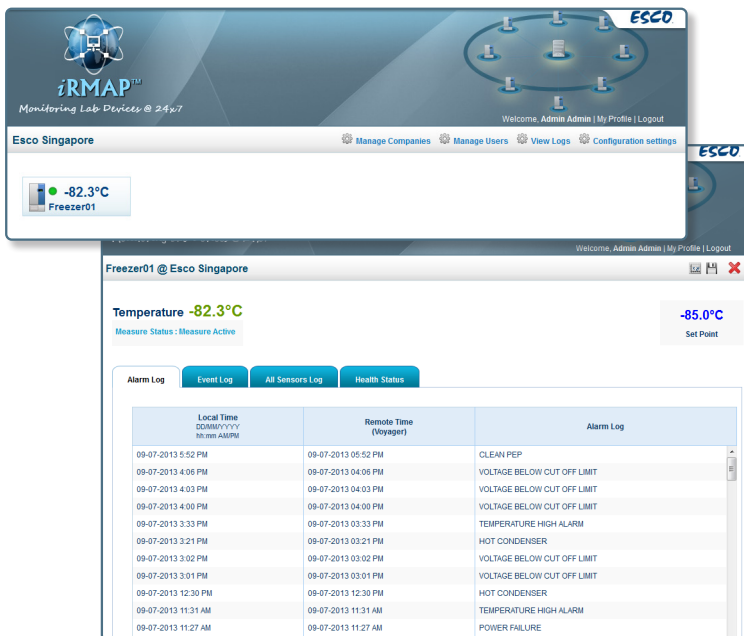

## PROtect GEN 2 - INDEPENDENT AND REDUNDANT MONITORING SYSTEM

- PROtect Gen 2 has no dependency on the freezer electronics so, in the event of a catastrophic failure that would prevent all other systems from notifying the user, PROtect can provide the necessary alerts to protect your irreplaceable samples.
- Multiple installations in remote buildings can be monitored and multiple users can access the system simultaneously.
- The PROtect sensors measure, record, and transmit data measurements via the Esco operator network or a private Esco gateway. Very low power consumption (battery life up to 4 years).
- Can be used in ULT freezers (-86°C), cryogenic applications (-196°C), and standard lab refrigerators (4°C) and freezers (-30 to -40°C).
- The sensors are equipped with an internal memory that is able to record up to 10,000 data points.



### LEGEND



PROtect G2 T0, T1, T2, T3  
 PROtect G2 Digital  
 PROtect G2 U  
 PROtect G2



ESCO Protect  
 Gateway



Email Alert



Ethernet Network



Radio Communication  
 (500 - 1000 m)

# ESCO LIFESCIENCES GROUP

42 LOCATIONS IN 21 COUNTRIES ALL OVER THE WORLD

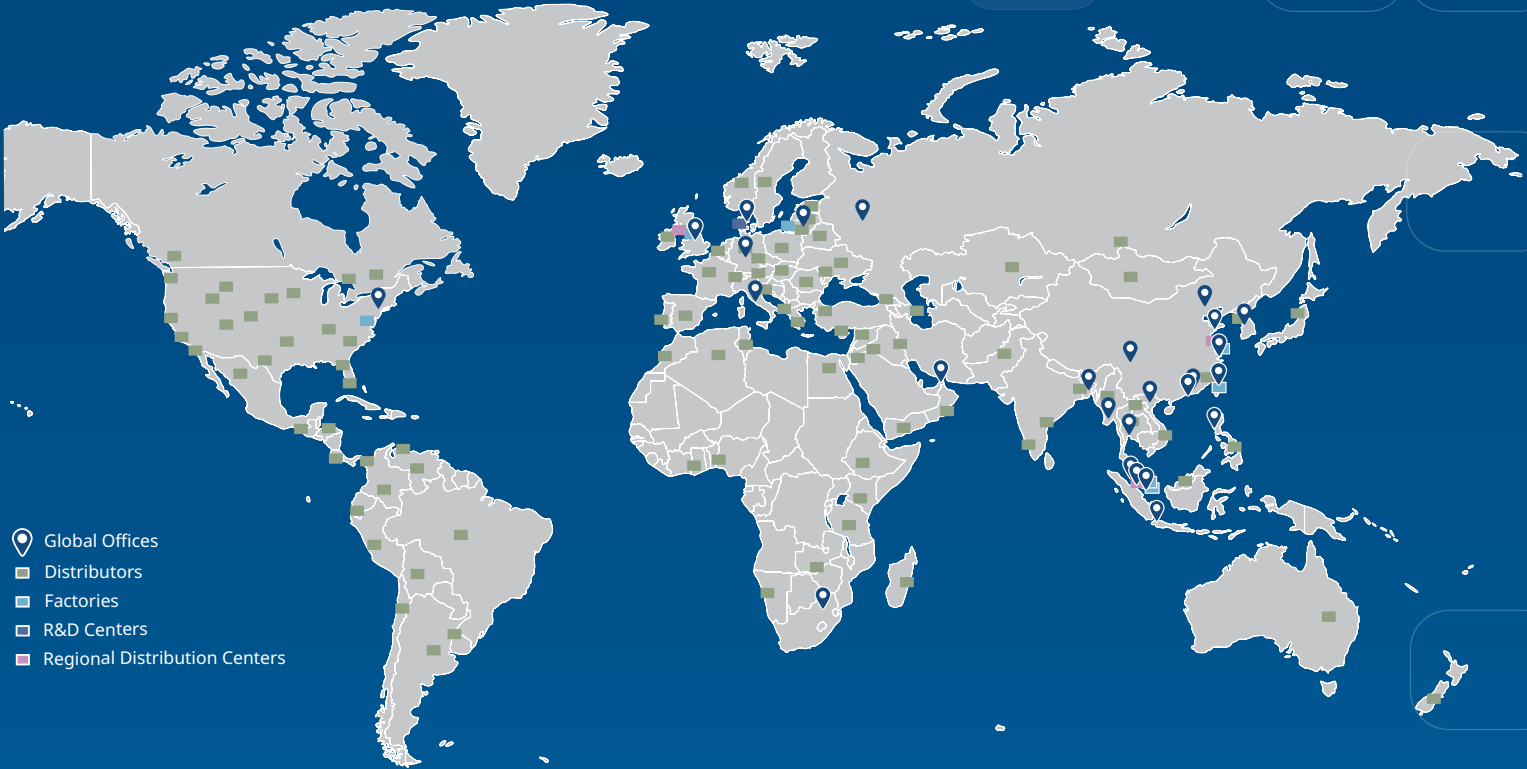

- 📍 Global Offices
- Distributors
- Factories
- R&D Centers
- Regional Distribution Centers

Follow us on social media, download our apps,  
and scan the QR code for more info.



@EscoLifesciences



@EscoLifesciences



@EscoLifesci



@Esco



@EscoLifesciences



@EscoLifesciences



Esco Lifesciences



Esco Lifesciences

# ESCO

LIFESCIENCES GROUP

Esco Micro Pte. Ltd. • 19 Changi South Street 1 • Singapore 486 779  
Tel +65 6542 0833 • mail@escolifesciences.com  
www.escolifesciences.com

Esco Technologies, Inc. • 903 Sheehy Drive, Suite F, Horsham, PA 19044, USA  
Tel: +1 215-441-9661 • Fax 484-698-7757  
eti.admin@escolifesciences.com

Esco Lifesciences Group Offices: Bangladesh | China | Denmark | Germany | HongKong | India | Indonesia | Italy | Japan | Lithuania  
| Malaysia | Myanmar | Philippines | Russia | Singapore | South Africa | South Korea | Taiwan | Thailand | UAE | UK | USA | Vietnam